







Propeller Calculation Data Sheet



 Inquiry



 Order

Name* _____
 Street* _____
 City* _____
 Country* _____
 Phone _____ Fax _____
 E-Mail _____







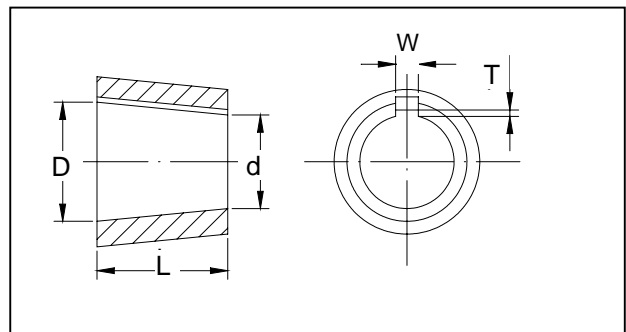
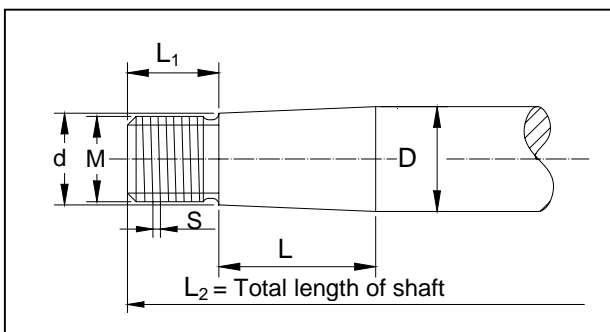

requested Propellertype?
 Fixed Feathering Folding
 available as  2-bl.  3-bl.  4-bl.
 Autoprop  2-bl.  3-bl.







Ship Data
 Manufacturer _____
 Model _____
 Year of construction ____ Saildrive  yes  no
 L_{oa} _____ L_{WL}* _____
 B_{WL} _____ Draught _____
 Weight in to. _____ or lbs _____
 Design loaded weight in to. _____ or lbs _____
 speed _____ knots at max. RPM
 cruising speed _____ knots at _____ RPM





Engine Data
 How many engines* _____
 Manufacturer/Model* _____
 Max. RPM* _____
 HP* _____ or kW _____
 Type of Gearbox _____
 Ratio * _____
 Shaft Diameter * _____
 SAE *  yes  no

only required if not SAE:
 Taper measured at  Shaft  Propeller
 D = ____ d = ____ L = ____ Key width = ____
 Thread (M) ____ Thread pitch (S) ____



Present Propeller
 Diameter _____ inch or _____ mm
 Pitch _____ inch or _____ mm
 Direction of rotation  RH  LH
 Fixed  2-bl.  3-bl.  4-bl.
 Feathering  2-bl.  3-bl.
 Folding  2-bl.  3-bl.

Type of boat
 Sailing
 Catamaran
 Motorsailing
 Motorboat
 Trawler
 Tug

Hull Type
 Displacement
 Semi Displacement
 Planing
Chine
 Round
 Hard

Note: Date marked * are essential



additionally needed data (not required if Saildrive)

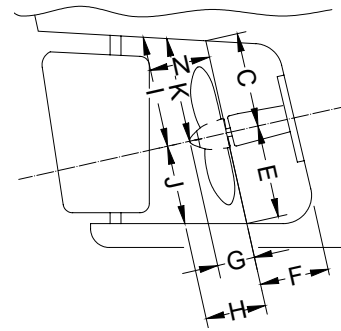
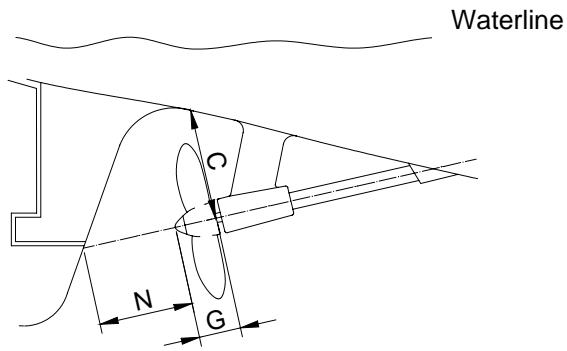

C = _____ mm	I = _____ mm
E = _____ mm	J = _____ mm
F = _____ mm	K = _____ mm
G = _____ mm	N = _____ mm
H = _____ mm	

Comments/other details:

Comment to the propeller-calculation:

Please fill in this information-list carefully, because the data stated by you give us the basis for the propeller calculation.

We point out that a calculated propeller is always only a recommendation!

A guarantee, that the calculated propeller is the „right one“, cannot be given since even the computer calculation is only a theoretical at the optimum. Only the test drive shows actual results. If these should not correspond to the expected optimal conditions, an should be made of the propeller.

Consequential expenses like Slip-, Assembling- and Carriage charges are not of responsibility of SPW!

Date _____

Signature: _____